

e2v

ADC EV10AS152A Evaluation Board

User Guide

Table of Contents

Section 1

| | |
|-----------------------|-----|
| Introduction | 1-1 |
| 1.1 Scope | 1-1 |
| 1.2 Description | 1-1 |

Section 2

| | |
|-------------------------------------|-----|
| Hardware Description | 2-1 |
| 2.1 Board Structure | 2-1 |
| 2.2 Analog Inputs/Clock Input | 2-2 |
| 2.3 Digital Output | 2-3 |
| 2.4 Reset Lines | 2-5 |

Section 3

| | |
|--------------------------------------|-----|
| Operating Characteristics | 3-1 |
| 3.1 Introduction | 3-1 |
| 3.2 Operating Procedure | 3-1 |
| 3.3 Electrical Characteristics | 3-2 |
| 3.4 Digital Output Coding | 3-4 |

Section 4

| | |
|---------------------------|-----|
| Software Tools | 4-1 |
| 4.1 Overview | 4-1 |
| 4.2 Configuration | 4-1 |
| 4.3 Getting Started | 4-1 |
| 4.4 Operating Modes | 4-7 |

Section 5

| | |
|---|-----|
| Application Information | 5-1 |
| 5.1 Introduction | 5-1 |
| 5.2 Analog Inputs | 5-1 |
| 5.3 Clock Inputs | 5-1 |
| 5.4 Digital Outputs | 5-1 |
| 5.5 ADC Functions | 5-2 |
| 5.6 DMUX Functions | 5-2 |
| 5.7 Diode for Die Junction Temperature Monitoring | 5-4 |
| 5.8 Test Bench Description | 5-6 |

Section 6

| | |
|-----------------------------------|-----|
| Package Information | 6-1 |
| 6.1 Thermal Characteristics | 6-1 |

Section 7
Ordering Information..... 7-1

Section 8
Appendix..... 8-1
 8.1 EV10AS152A-EB Electrical Schematics.....8-1
 8.2 EV10AS152A-EB Board Layers.....8-8

Section 1

Introduction

Preamble

This document has to be read with the latest version of the datasheet that can be found on e2v.com website.

-
- 1.1 Scope**
- The ADC EV10AS152A-EB Evaluation Kit is designed to facilitate the evaluation and characterization of the different versions of EV10AS152A ADC with 1:2/4 DMUX up to its full power input bandwidth.
- The ADC EV10AS152A-EB Evaluation Kit includes:
- The EV10AS152A with 1:2/4 DMUX Evaluation board including one version of the EV10AS152A ADC device soldered on the board
 - Six SMA caps for CLK, CLKN, VIN, VINN, DRR and ASYNCRST signals
 - Six jumpers DMUX function settings (RS, BIST, DRTYPE, SLEEP, STAGG), CLKTYPE jumper is not used
 - 3-wire serial link to control ADC functionality
- The user guide uses the EV10AS152A Evaluation Kit as an evaluation and demonstration platform and provides guidelines for its proper use.
-
- 1.2 Description**
- The ADC EV10AS152A Evaluation board is very straightforward as it only implements the EV10AS152A ADC/DMUX device, SMA connectors for the sampling clock, analog inputs and reset inputs accesses and HE14 double row 2.54 mm pitch connectors compatible with high speed acquisition system probes.
- To achieve optimal performance, the ADC EV10AS152A-EB Evaluation board was designed in a 8-metal-layer board with RO4003 200 μm and FR4 HTG epoxy dielectric materials. The board implements the following devices:
- The ADC EV10AS152A with 1:2/4 DMUX Evaluation board with one version of the EV10AS152A ADC soldered on the board
 - Six SMA caps for CLK, CLKN, VIN, VINN, DRR and ASYNCRST signals
 - Six jumpers DMUX function settings (RS, BIST, DRTYPE, SLEEP, STAGG), CLKTYPE jumper is not used
 - 3-wire serial link to control ADC functionality via RS232
 - 2.54 mm pitch connectors for the digital outputs, compatible with high speed acquisition system probes

- Banana jacks for the power supply accesses and the die junction temperature monitoring functions (2 mm)
- Potentiometers for the DMUX functions

The board is composed of eight metal layers for signal traces, ground and power supply layers, and seven dielectric layers featuring low insertion loss and enhanced thermal characteristics for operation in the high frequency domain.

The board dimensions are 220 mm x 240 mm.

The board comes fully assembled and tested, with one version of the EV10AS152A ADC installed.

Figure 1-1. ADC EV10AS152A-EB Evaluation Board Simplified Schematic

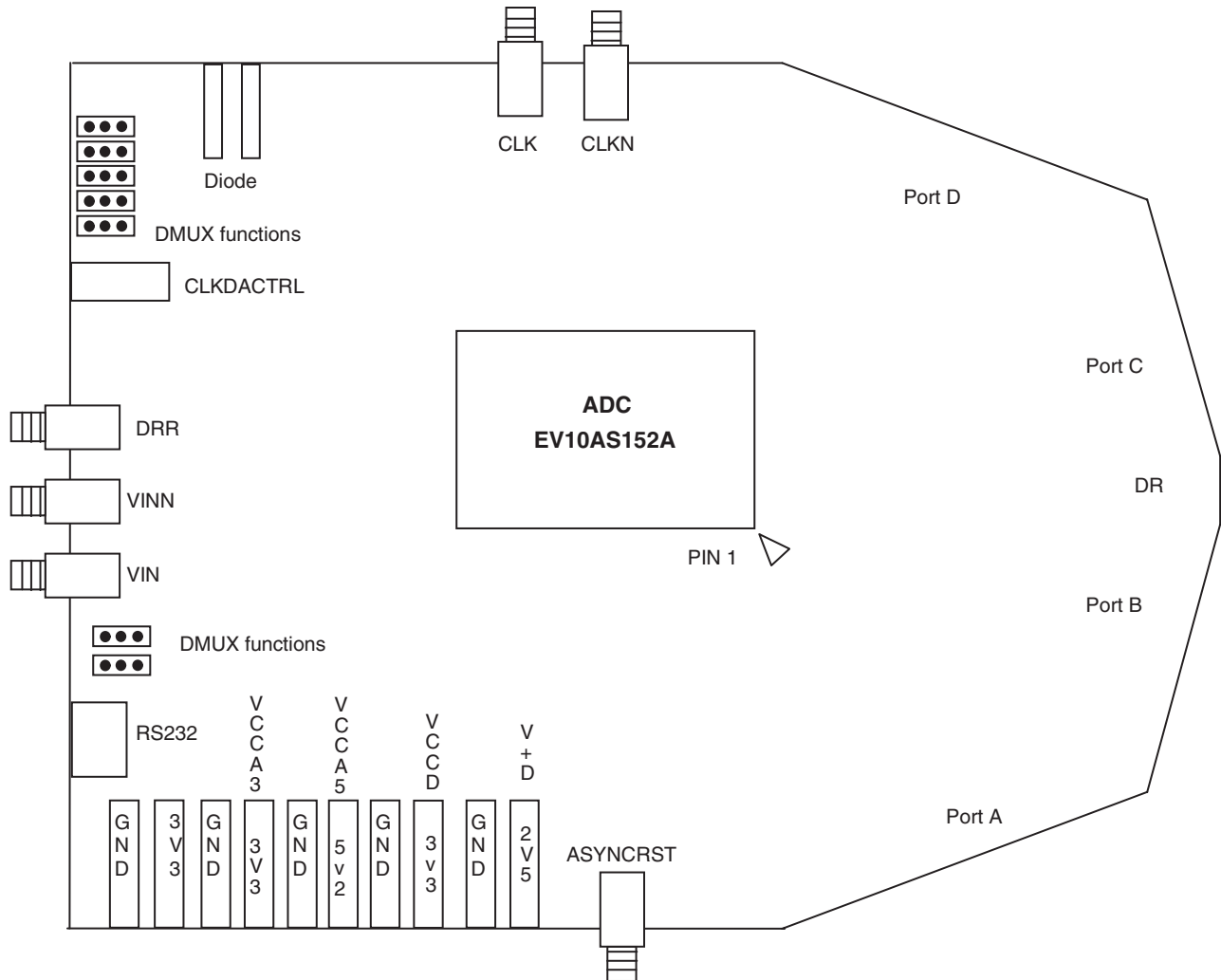

As shown in Figure 1-1, different power supplies are required:

- V_{CCA5} = 4.9V analog positive power supply
- V_{CCA3} = 3.25V analog positive power supply
- V_{CCD} = 3.3V digital positive power supply
- V_{PLUSD} = 2.5V digital output power supply
- 3.3V power supply for the board functions

Hardware Description

2.1 Board Structure

In order to achieve optimum full speed operation of the ADC EV10AS152A with 1:2/4 DMUX, a multilayer board structure was retained for the evaluation board. Eight copper layers are used, respectively dedicated to the signal traces, ground planes, power supply planes and DC signals traces.

The board is made in RO4003 200 μm and FR4 HTG epoxy dielectric materials. Table 2-1 gives a detailed description of the board's structure.

Table 2-1. Board Layer Thickness Profile

| Layer | Characteristics |
|--|---|
| Layer 1 Copper layer | Copper thickness = 40 μm AC signals traces = 50 Ω microstrip lines DC signals traces (DMUX functionality etc.) |
| Layer 2 RO4003 dielectric layer (Hydrocarbon/wovenglass) | Layer thickness = 200 μm Dielectric constant = 3.4 at 10 GHz -0.044 dB/inch insertion loss at 2.5 GHz -0.318 dB/inch insertion loss at 18 GHz |
| Layer 3 Copper layer | Copper thickness = 35 μm Upper ground plane = reference plane 50 Ω microstrip return |
| Layer 4 FR4 HTG/dielectric layer | Layer thickness = 170 μm |
| Layer 5 Copper layer | Copper thickness = 35 μm Power planes = V_{CCA5} |
| Layer 6 FR4 HTG/dielectric layer | Layer thickness = 200 μm |
| Layer 7 Copper layer | Copper thickness = 35 μm Power planes = V_{CCD} and 3.3V |
| Layer 8 FR4 HTG/dielectric layer | Layer thickness = 170 μm |

Table 2-1. Board Layer Thickness Profile (Continued)

| | |
|--------------------------------------|---|
| Layer 9 Copper layer | Copper thickness = 35 μm Power planes = V_{CCA3} |
| Layer 10 FR4 HTG/dielectric layer | Layer thickness = 200 μm |
| Layer 11 Copper layer | Copper thickness = 35 μm Power planes = V_{PLUSD} |
| Layer 12 FR4 HTG/dielectric layer | Layer thickness = 170 μm |
| Layer 13 Copper layer | Copper thickness = 35 μm Ground plane = reference plane (identical to layer 3) |
| Layer 14 FR4 HTG/dielectric layer | Layer thickness = 200 μm |
| Layer 15 Copper layer | Copper thickness = 40 μm DC signals traces and Serial Interface (AVR) signals Ground plane |

The board is 1.6 mm thick.

The clock, analog input, reset and digital data output signals occupy the top metal layer while the ADC and DMUX functions are located both on the top.

The ground planes occupy layer 3, 13 and 15 (partly).

Layer 5, 7, 9 and 11 are dedicated to the power supplies.

2.2 Analog Inputs/Clock Input

The differential active inputs (Clock, Analog) are provided by SMA connectors.

Reference: VITELEC 142-0701-8511

Special care was taken for the routing of the analog input and clock input signals for optimum performance in the high frequency domain:

- 50 Ω lines matched to ± 0.1 mm (in length) between V_{IN} and V_{INN} and between CLK and CLKN
- 50 mm max line length
- 1.27 mm pitch between the differential traces
- 400 μm line width
- 40 μm thickness
- 850 μm diameter hole in the ground layer below the V_{IN} , V_{INN} , CLK and CLKN ball footprints

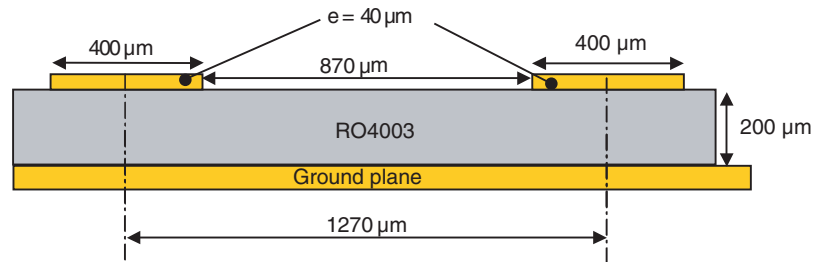
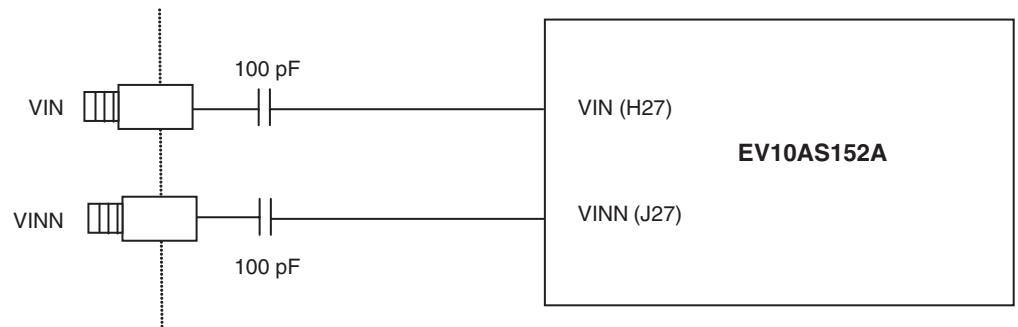
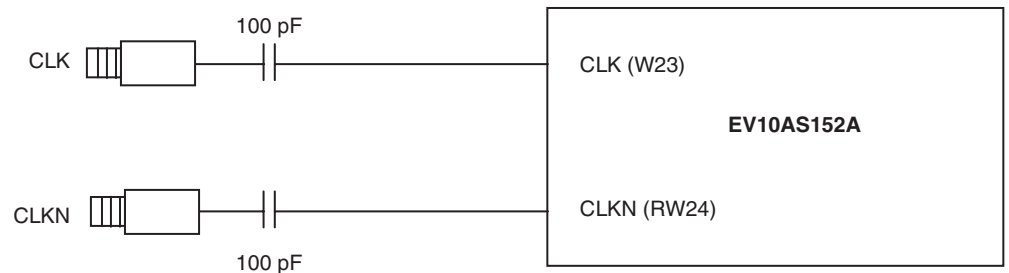
Figure 2-1. Figure 2-1.Board Layout for the Differential Analog and Clock Inputs**Figure 2-2.** Differential Analog Inputs Implementation**Figure 2-3.** Differential Clock Inputs Implementation

2.3 Digital Output

The digital output lines were designed with the following recommendations:

- 50Ω lines matched to ± 0.5 mm (in length) between signal of the same differential pair
- 80 mm max line length
- ± 1 mm line length difference between signals of two ports
- ± 1.5 mm max line length difference between all signals
- 770 μm pitch between the differential traces
- 370 μm line width
- 40 μm thickness

Figure 2-4. Board Layout for the Differential Digital Outputs

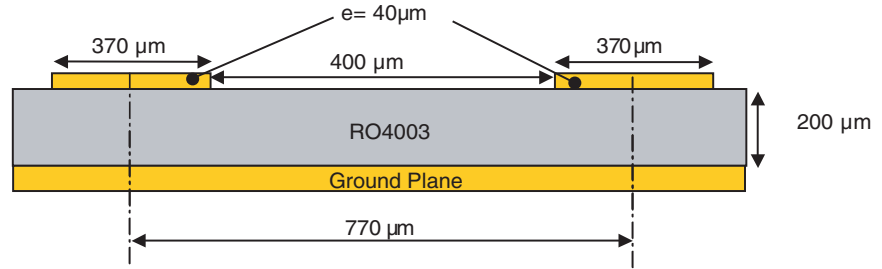

The digital outputs are compatible with LVDS standard. They are on-board 100Ω differentially terminated as described in Figure 2-5.

Figure 2-5. Differential digital Outputs Implementation

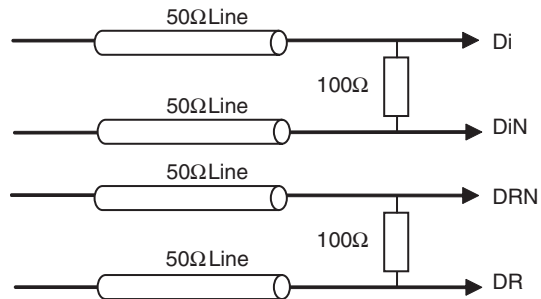

HE14 Double row 2.54 mm pitch connectors are used for the digital output data. The upper row is connected to the signal while the lower row is connected to Ground, as illustrated in Figure 2-6.

Figure 2-6. Differential Digital Outputs 2.54 mm Pitch Connector (Example Port A)

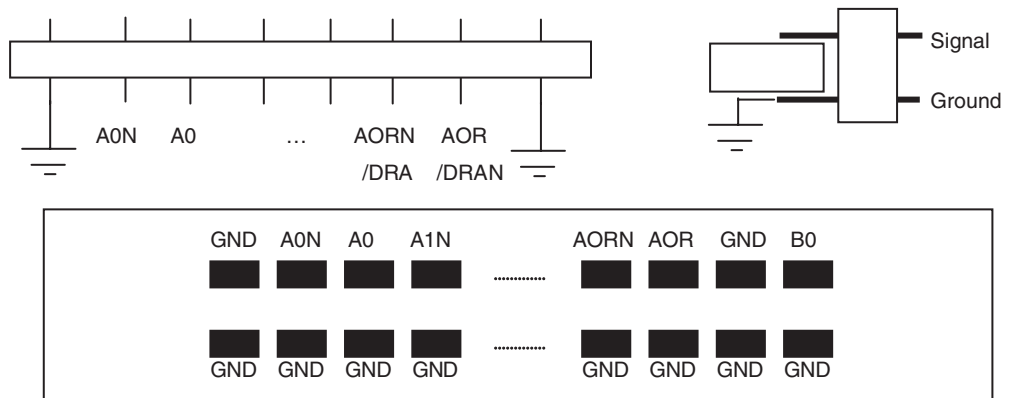

Figure 2-7. Differential Digital Clock Outputs 2.54 Mm Pitch Connector



2.4 Reset Lines

The reset line (DRR and ASYNCRST) were designed with the following recommendations:

- 50Ω lines
- 80 mm max line length
- 430 μm line width
- 40 μm thickness

Figure 2-8. Board Layout for the Single Reset Lines

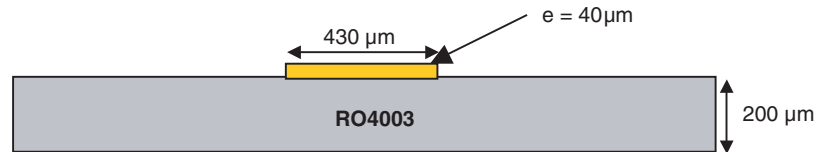

Operating Characteristics

-
- 3.1 Introduction** This section describes a typical configuration for operating the evaluation board of the ADC EV10AS152A with 1:2/4 DMUX.
- The analog input signal can be entered either in differential or single ended. Refer to the datasheet for the impact of driving analog input in single or in differential. The clock input signal must be differentially driven.
- ADC EV10AS152A clock inputs should be fed with balanced signals (use a balun or hybrid junction to convert a single signal to a differential signal).
-
- 3.2 Operating Procedure**
1. Connect the power supplies and ground accesses through the dedicated banana jacks.
 $V_{CCA5} = 4.9V$, $V_{CCA3} = 3.25V$, $V_{CCD} = 3.3V$, $V_{PLUSD} = 2.5V$,
 $V_{CCA3} = 4.9V$, $V_{CCD} = 3.3V$ and $3.3V$ have separated planes but can be reunited via a short-cable.
 2. Connect the clock input signals. Use a low-phase noise high frequency generator.
 The clock input level is typically 1 dBm (on 100Ω differential input). The clock frequency can range from 500 MHz up to maximum speed.
 3. Connect the analog input signal. Use a low-phase noise high frequency generator.
 The analog input full scale is 500 mV peak-to-peak (± 250 mV on each single ended input) around 0V (AC coupling). It is recommended to use the ADC with an input signal of -1 dBFS max (to avoid saturation of the ADC).
 The analog input frequency can range from DC up to 5 GHz. At 5 GHz, the ADC attenuates the input signal by 3 dB.
 4. Connect the high-speed acquisition system probes to the output connectors.
 The digital data are differentially terminated on-board (100Ω) however, they can be probed either in differential or in single-ended mode.
 5. Connect the DMUX function jumpers:
 All instrumentation and connectors are now connected.
 6. Switch on the power supplies (No specific power supplies sequencing required during power on/off).
 7. Turn on the RF clock generator.
 8. Turn on the RF signal generator.

Operating Characteristics

9. Perform an asynchronous Reset (DRR active) on the device and maintain this Reset active.
10. Perform an asynchronous Reset ((push button) ASYNCRST active) on the board.
11. Then, ASYNCRST inactive on the board.
12. DRR inactive on the device.
13. Started 3 Wire Serial interface (refer to Section 4)
14. Reset button allows to configure ADC (Mode 0)

3.3 Electrical Characteristics

Table 3-1. Absolute Maximum Ratings

| Parameter | Symbol | Value | Unit |
|---|--|----------------------------------|------|
| Analog 5.0V Power Supply voltage | V_{CCA5} | GND to 6.0 | V |
| Analog 3.3V Power Supply voltage | V_{CCA3} | GND to 3.6 | V |
| Digital 3.3V Power Supply Voltage | V_{CCD} | GND to 3.6 | V |
| Output 2.5V Power Supply voltage | V_{PLUSD} | GND to 3.0 | V |
| Minimum Analog input peak voltage (with differential input) | V_{IN} or V_{INN} | 2.0 | V |
| Maximum Analog input peak voltage (with differential input) | V_{IN} or V_{INN} | 4.0 | V |
| Maximum difference between V_{IN} and V_{INN} (with differential input) | $ V_{IN} - V_{INN} $ | 2.0 (4 Vpp = +13 dBm in 100Ω) | V |
| Minimum Analog input peak voltage (with single ended input) | V_{IN} with $V_{INN} = 50\Omega$ to GND or V_{INN} with $V_{IN} = 50\Omega$ to GND | 2.0 | V |
| Maximum Analog input peak voltage (with single ended input) | V_{IN} with $V_{INN} = 50\Omega$ to GND or V_{INN} with $V_{IN} = 5\Omega$ to GND | 4.0 | V |
| Maximum amplitude on V_{IN} or V_{INN} (with single ended input) | $ V_{IN} $ or $ V_{INN} $ | (2 Vpp = +10 dBm in 50Ω) | V |
| Minimum Clock input peak voltage (with differential clock) | V_{CLK} or V_{CLKN} | 1.5 | V |
| Maximum Clock input peak voltage (with differential clock) | V_{CLK} or V_{CLKN} | 4.0 | V |
| Maximum difference between V_{CLK} and V_{CLKN} (with differential clock) | $ V_{CLK} - V_{CLKN} $ | 1.5 (3 Vpp) | V |
| 3WSI input voltage | SDATA, SLDN, SCLK, RESET | -0.3 to $V_{CCA3} + 0.3$ | V |
| ADC Reset Voltage | DRR | -0.3 to $V_{CCA3} + 0.3$ | V |
| DMUX function input voltage | RS, DRTYPE, SLEEP, STAGG, BIST | -0.3 to $V_{CCD} + 0.3$ | V |
| DMUX Asynchronous Reset | ASYNCRST | -0.3 to $V_{CCD} + 0.3$ | V |
| DMUX Control Voltage | CLKDACTRL | -0.3 to $V_{CCD} + 0.3$ | V |

Table 3-1. Absolute Maximum Ratings (Continued)

| | | | |
|--------------------------------|------------------|--|----|
| Maximum input voltage on DIODE | DIODE ADC | 700 | mV |
| Maximum input current on DIODE | DIODE ADC | 1 | mA |
| Max Junction Temperature | T _J | 135 | °C |
| Storage temperature | T _{stg} | -55 to 150 | °C |
| ESD protection (HBM) | | ≥ 500 on ADC inputs 500 on DMUX outputs | V |

Note: Absolute maximum ratings are limiting values (referenced to GND = 0V), to be applied individually, while other parameters are within specified operating conditions. Long exposure to maximum rating may affect device reliability.
All integrated circuits should be handled with appropriate care to avoid damages due to ESD. Damage caused by inappropriate handling or storage could range from performance degradation to complete failure, including reliability degradation.

Table 3-2. Electrical Characteristics for Supplies

| Parameter | Test Level | Symbol | Min | Typ | Max | Unit |
|--|------------|---------------------|------|------|------|------|
| POWER REQUIREMENTS | | | | | | |
| Power Supply voltages | 1 | | | | | |
| Analog V _{CCA5} = 4.9V | | V _{CCA5} | 4.75 | 4.9 | 5.05 | V |
| Analog V _{CCA3} = 3.25V | | V _{CCA3} | 3.15 | 3.25 | 3.35 | V |
| Digital V _{CCD} = 3.3V | | V _{CCD} | 3.15 | 3.3 | 3.45 | V |
| Output V _{PLUSD} = 2.5V | | V _{PLUSD} | 2.4 | 2.5 | 2.6 | V |
| Power Supply current in 1:2 DMUX | 1 | | | | | |
| Analog V _{CCA5} = 4.9V | | I _{VCCA5} | | 150 | 190 | mA |
| Analog V _{CCA3} = 3.25V | | I _{VCCA3} | | 850 | 990 | mA |
| Digital V _{CCD} = 3.3V | | I _{VCCD} | | 350 | 430 | mA |
| Output V _{PLUSD} = 2.5V | | I _{VPLUSD} | | 470 | 620 | mA |
| Power Supply current in 1:4 DMUX | 1 | | | | | |
| Analog V _{CCA5} = 4.9V | | I _{VCCA5} | | 150 | 190 | mA |
| Analog V _{CCA3} = 3.25V | | I _{VCCA3} | | 850 | 990 | mA |
| Digital V _{CCD} = 3.3V | | I _{VCCD} | | 400 | 470 | mA |
| Output V _{PLUSD} = 2.5V | | I _{VPLUSD} | | 490 | 650 | mA |
| Power Supply current in NAP and SLEEP mode | 1 | | | | | |
| Analog V _{CCA5} = 4.9V | | I _{VCCA5} | | 110 | 150 | mA |
| Analog V _{CCA3} = 3.25V | | I _{VCCA3} | | 560 | 800 | mA |
| Digital V _{CCD} = 3.3V | | I _{VCCD} | | 130 | 150 | mA |
| Output V _{PLUSD} = 2.5V | | I _{VPLUSD} | | 400 | 550 | mA |
| Power dissipation | 1 | P _D | | | | |
| - 1:2 DMUX | | | | 5.8 | 7.4 | W |
| - 1:4 DMUX | | | | 6.0 | 7.6 | W |
| - NAP & SLEEP mode (1:4 or 1:2) | | | | 3.8 | 5.4 | W |

3.4 Digital Output Coding

Table 3-3. Digital Output Coding

| Differential Analog Input | Voltage Level | Digital Output | | |
|---------------------------|--|---|---|--|
| | | Natural Binary ⁽¹⁾ MSB.....LSB OR | Binary 2's Complement ⁽¹⁾ MSB.....LSB OR | Gray Coding ⁽¹⁾ MSB.....LSB OR |
| > 250.25 mV | >Top end of full scale + ½ LSB | 0 0 0 0 0 0 0 0 0 0 1 | 1 0 0 0 0 0 0 0 0 0 1 | 0 1 1 1 1 1 1 1 1 1 1 |
| 250.25 mV | Top end of full scale + ½ LSB | 0 0 0 0 0 0 0 0 0 0 0 | 1 0 0 0 0 0 0 0 0 0 0 | 0 1 1 1 1 1 1 1 1 1 0 |
| 249.75 mV | Top end of full scale - ½ LSB | 0 0 0 0 0 0 0 0 0 1 0 | 1 0 0 0 0 0 0 0 0 1 0 | 0 1 1 1 1 1 1 1 1 0 0 |
| 125.25 mV | ³ / ₄ full scale + ½ LSB | 0 0 1 1 1 1 1 1 1 1 0 | 1 0 1 1 1 1 1 1 1 1 0 | 0 1 0 1 1 1 1 1 1 1 0 |
| 124.75 mV | ³ / ₄ full scale - ½ LSB | 0 1 0 0 0 0 0 0 0 0 0 | 1 1 0 0 0 0 0 0 0 0 0 | 0 0 0 1 1 1 1 1 1 1 0 |
| 0.25 mV | Mid scale + ½ LSB | 0 1 1 1 1 1 1 1 1 1 0 | 1 1 1 1 1 1 1 1 1 1 0 | 0 0 1 1 1 1 1 1 1 1 0 |
| -0.25 mV | Mid scale - ½ LSB | 1 0 0 0 0 0 0 0 0 0 0 | 0 0 0 0 0 0 0 0 0 0 0 | 1 0 1 1 1 1 1 1 1 1 0 |
| -124.75 mV | ¹ / ₄ full scale + ½ LSB | 1 0 1 1 1 1 1 1 1 1 0 | 0 0 1 1 1 1 1 1 1 1 0 | 1 0 0 1 1 1 1 1 1 1 0 |
| -124.25 mV | ¹ / ₄ full scale - ½ LSB | 1 1 0 0 0 0 0 0 0 0 0 | 0 1 0 0 0 0 0 0 0 0 0 | 1 1 0 1 1 1 1 1 1 1 0 |
| -249.75 mV | Bottom end of full scale + ½ LSB | 1 1 1 1 1 1 1 1 1 1 0 | 0 1 1 1 1 1 1 1 1 1 0 | 1 1 1 1 1 1 1 1 1 1 0 |
| -250.25 mV | Bottom end of full scale - ½ LSB | 1 1 1 1 1 1 1 1 1 1 0 | 0 1 1 1 1 1 1 1 1 1 0 | 1 1 1 1 1 1 1 1 1 1 0 |
| <-250.25 mV | < Bottom end of full scale - ½ LSB | 1 1 1 1 1 1 1 1 1 1 1 | 0 1 1 1 1 1 1 1 1 1 1 | 1 1 1 1 1 1 1 1 1 1 1 |

MSB bit 9 and LSB bit 0.

- Notes:
1. Refer to chap. 4.4.4 and 4.4.5 for selection between natural binary, binary 2's complement or Gray coding.
 2. Be aware that code 0x000 is obtained for positive full scale analog input and code 0x3FF for negative full scale analog input.

Software Tools

-
- | | | |
|------------|------------------------|--|
| 4.1 | Overview | <p>The ADC EV10AS152A evaluation user interface software is a C++ compiled graphical interface.</p> <p>No license is required to run on a W98, NT, W2000, XP and Win7 PC.</p> <p>The software uses intuitive push buttons and popup menus to write data from the hardware.</p> |
| 4.2 | Configuration | <p>Advised configuration for Win2000:</p> <ul style="list-style-type: none">– PC Pentium >100 MHz– Memory 24Mo– For other versions of Windows OS, use the recommended configuration from Microsoft– Two COM ports are necessary to use two boards simultaneously |
| 4.3 | Getting Started | <p>Install the ADC EV10AS15x application on your computer by launching the EV10AS15x exe installer.</p> |
-

Figure 4-1. Install Window

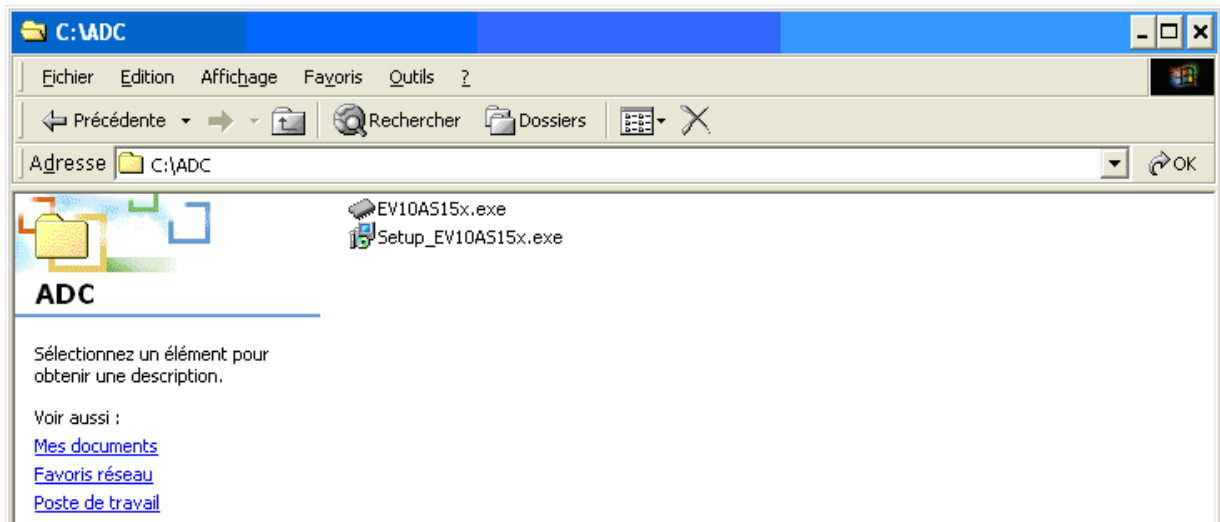

Start the Setup_EV10AS15x (v1.1.2)

Figure 4-2. EV10AS152A Application Set up Wizard Window

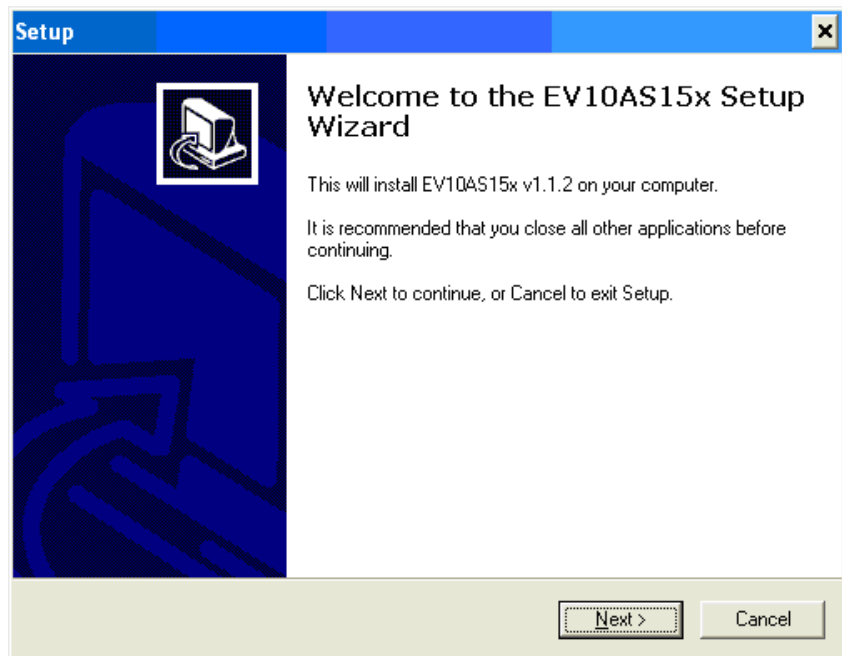

Next step: Select Destination Directory.

Figure 4-3. EV10AS152A select Destination Directory Window

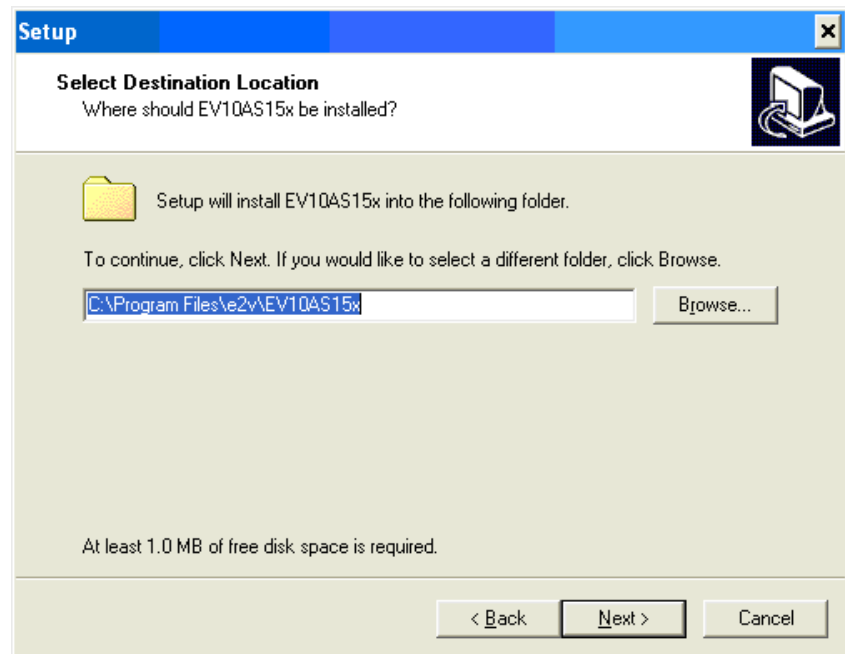

Next step: Start Menu Folder.

Figure 4-4. EV10AS152A select Start Menu Window

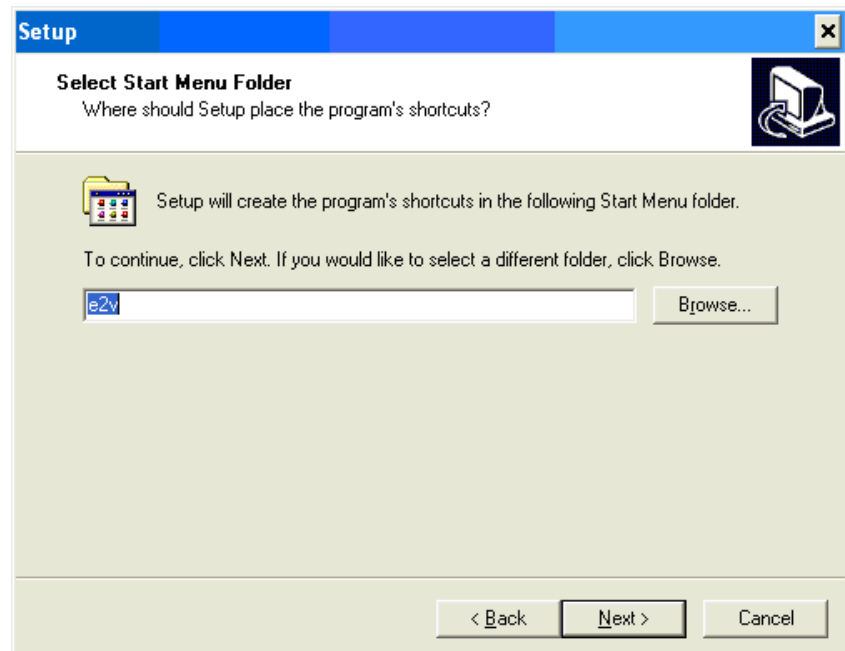

Next step: verification of the install configuration.

Figure 4-5. EV10AS152A Ready to Install Window

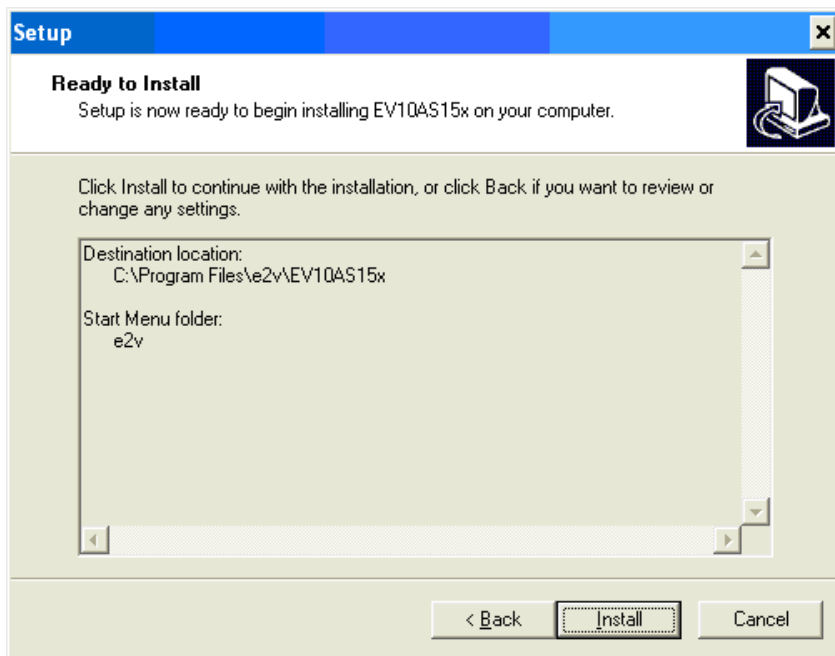

If you agree with the install configuration press *Install*.

Figure 4-6. EV10AS152A Application Setup Install Push Button



The software is completing installation.

Figure 4-7. EV10AS152A Completing Setup Wizard Window

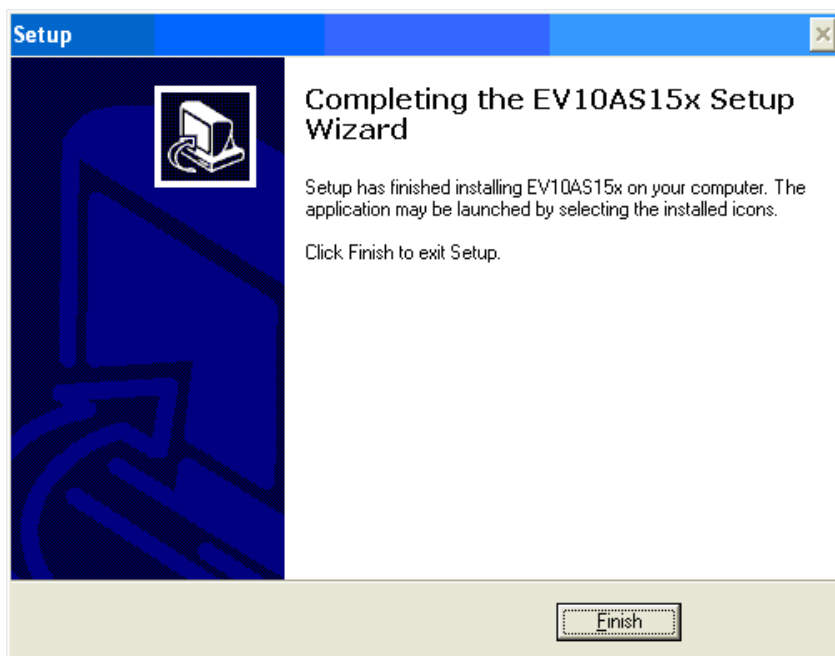

Now you can launch the ADC10Bit series software from its icon; the following screen will be displayed:

Figure 4-8. ADC EV10AS152A User Interface Window

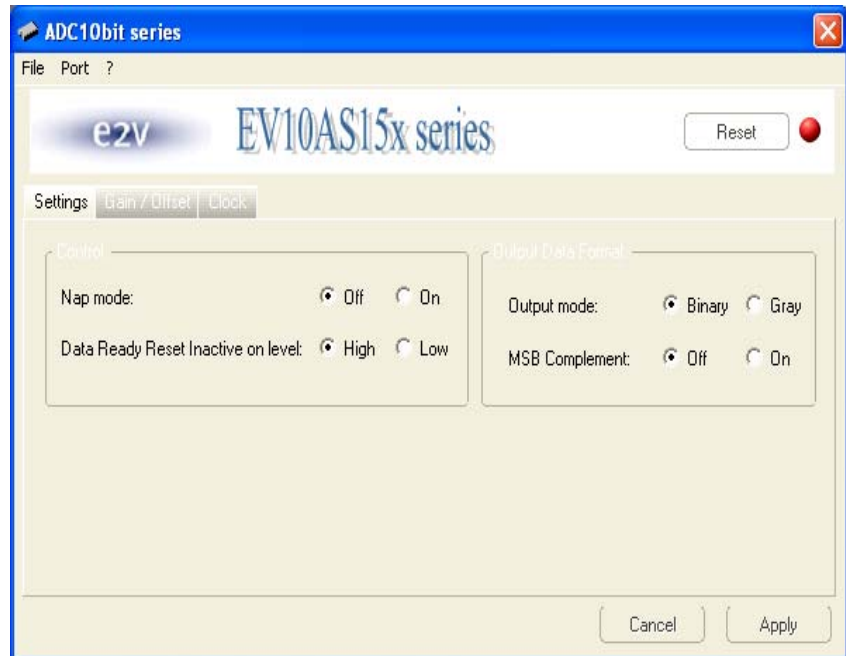
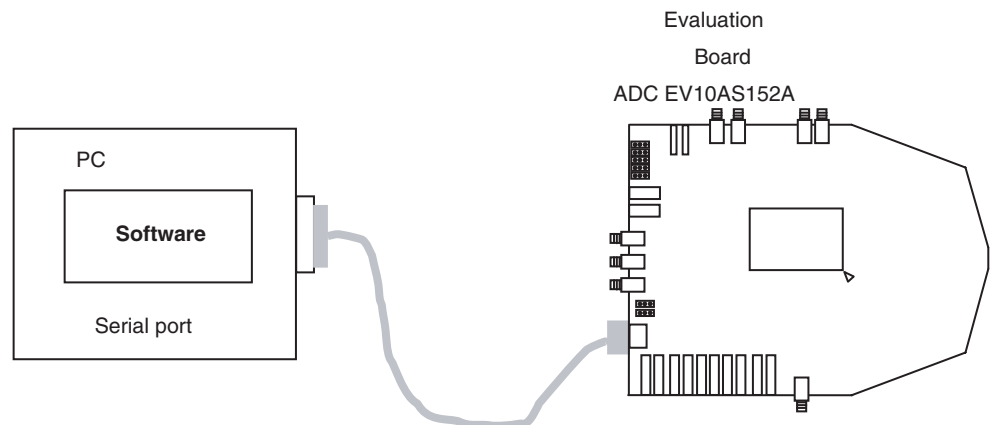
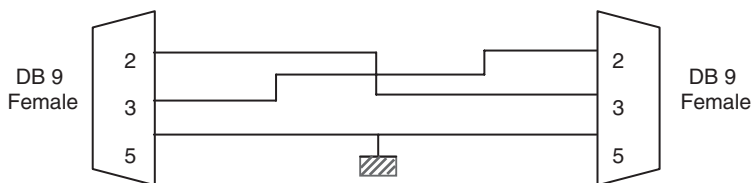

Figure 4-9. ADC10-bit User Interface Hardware Implementation



Use a RS 232 port to send data to ADC.

Connect the crossed DB9 9 (F/F) cable between your PC and your evaluation board.

Figure 4-10. Crossed RS232 Cable

Serial Port Configuration:

- Bit rate: 19200
- Data coding: 8 bit
- 1 start bit, 1 Stop bit
- No parity check

4.3.1 Installation Software At startup, the application automatically checks all RS 232 ports available on the computer and tries to find the evaluation board on them.

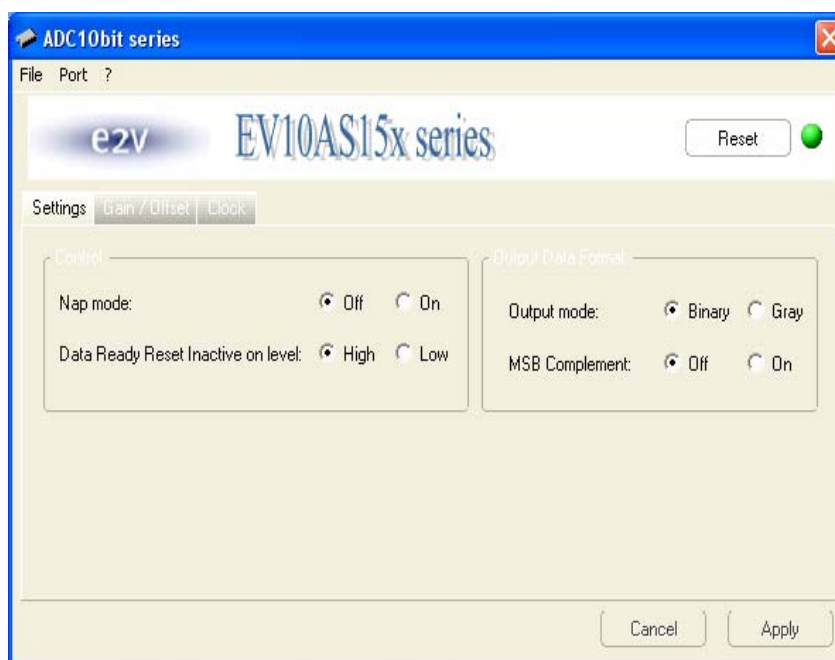
Figure 4-11. ADC EV10AS152A User Interface

The *Port* menu shows all available ports on your computer. The port currently used has a check mark on its left. By clicking another port item, the application will try to connect to an evaluation board via the selected port. If a board is successfully detected on the new port, the LED is green (or orange depending on the serial interface switch) and the new port gets the check mark. If the application is not able to find a board on this port, an error message is displayed and the LED turns to red.

4.3.2 Troubleshooting

If the ADC EV10AS152A evaluation board is not connected or not powered, a red LED appears on the right of the Reset button and the application is grayed

Figure 4-12. ADC EV10AS152A User Interface



Check the connection to the PC and restart the application.

If the serial interface is not active the LED appears in orange and the application is grayed too.

Figure 4-13. ADC EV10AS152A User Interface



Turn ON the switch on the demo board, the application should become available and the LED turns to green.

Troubleshooting:

- Check your rights to write in the directory
- Check for the available disk space
- Check that at least one RS232 serial port is free and properly configured.
- Check that the DB9 connector is properly inserted
- Check that all supplies are ON
- Check that the serial mode is active (green LED ON)

4.4 Operating Modes

4.4.1 Overview

The software provides a graphical user interface to configure the ADC. Push buttons, popup menus and capture windows allows playing with:

- Control Mode,
- Switch analog and Switch clock
- Standby
- Gain
- Offset
- DDA

Always click on *Apply* to validate any command

Each setting must be validated in its own tab.



Clicking on *Cancel* will restore last settings sent with *Apply* button.

Reset button allows to configure ADC (Mode 0)



4.4.2 Control Mode

The control mode allows controlling the NAP mode and Data Ready Reset Inactive mode.

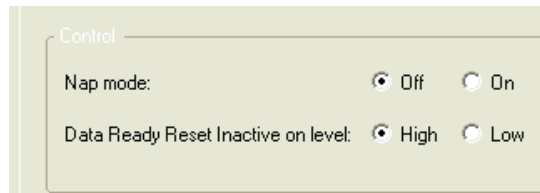

4.4.2.1 NAP Mode

NAP mode configurable Off or On

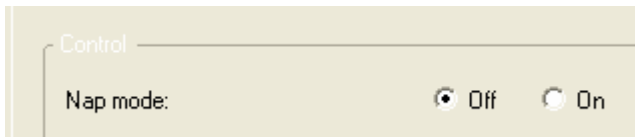

4.4.2.2 Data Ready Reset Inactive on Level

Data Ready Reset is inactive on High level or on Low level



4.4.3 ADC Output Data Format (Binary-Gray)

ADC Output Data Format: Binary

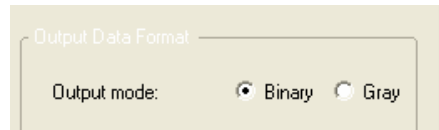

ADC Output Data Format: Gray

Note: In this mode, MSB complement is not available.

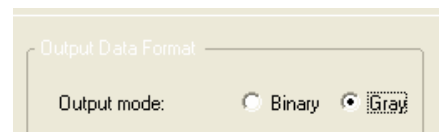

4.4.4 ADC Output Data Format (MSB Complement)

ADC Output Data Format: MSB complement Off

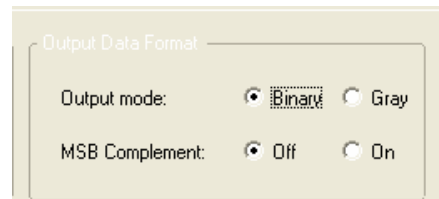

ADC Output Data Format: MSB complement On

Note: Mode MSB complement is available if ADC output data format is binary

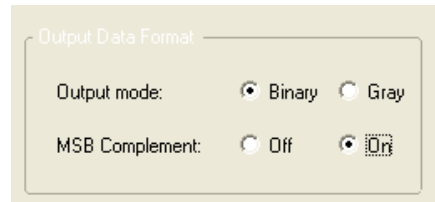

4.4.5 ADC Gain Adjust ADC Gain adjustment is from -0.5 to 0.5 dB.

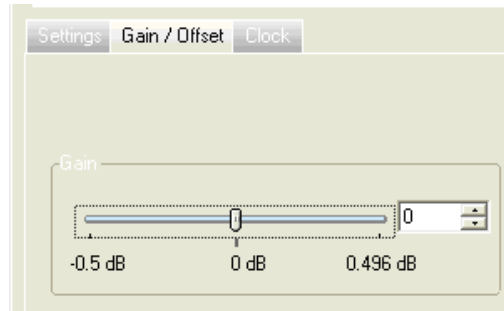

4.4.6 ADC Offset Adjust ADC Offset adjustment is from -20 mV to 20 mV.

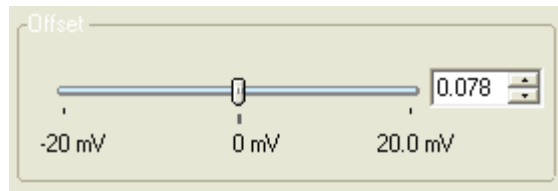

4.4.7 Sampling Delay Adjust

Sampling Delay Adjustment Off

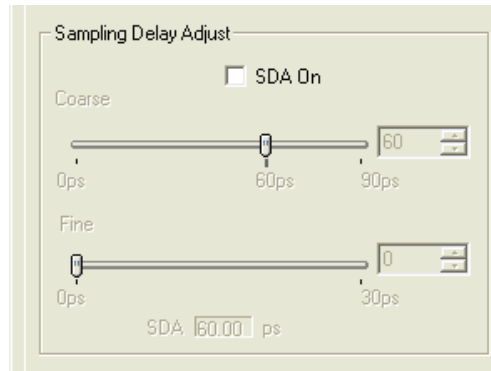

- Sampling delay adjustment On
- Coarse adjustment: 0 to 90 ps by step of 30 ps
- Fine adjustment: 0 to 30 ps by step of 0.118 ps
- Maximum delay: 120 ps

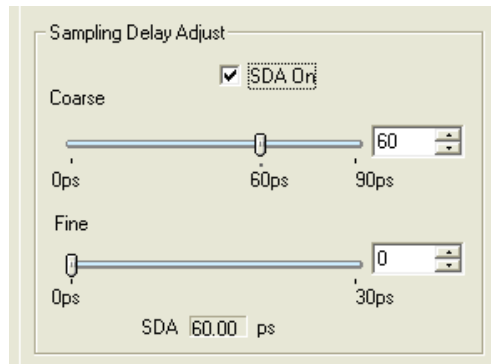

4.4.8 Advanced Setting: Logic Clock Adjustment

Internal logic clock adjustment 0 to 30 ps on Lsb register

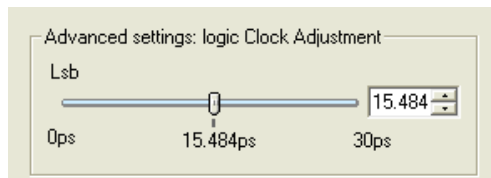

4.4.9 Clock Duty Cycle (Track - Hold)

ADC Duty Cycle (Track-Hold): 40%-60% to 30%-70%

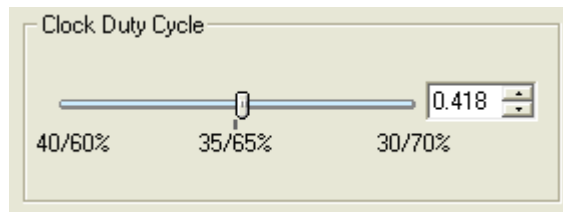

Note: Reset value 35%-65%

Application Information

-
- 5.1 Introduction** For this section, refer also to the product chapter 4 of the datasheet.
-
- 5.2 Analog Inputs** The analog input can be entered either single ended or differentially. Refer to the datasheet to see the impact on dynamic performances.
It is recommended to use a filter to optimize the dynamic performance and the spectral response of the ADC.
-
- 5.3 Clock Inputs** The clock inputs should be differentially driven using a balun or hybrid junction.
The clock input is AC coupled.
-
- 5.4 Digital Outputs** The digital outputs (data and Data Ready) are LVDS compatible. 100Ω differential termination is provided on-board.

Figure 5-1. Differential Digital Outputs Implementation

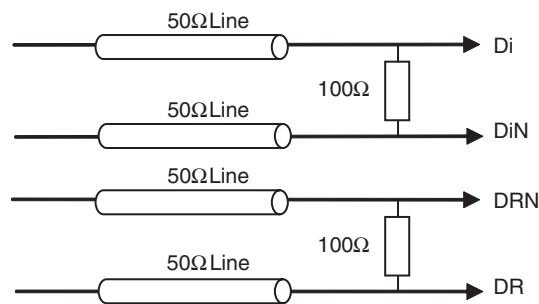

5.5 ADC Functions

5.5.1 DRR (Data Ready Reset)

The Data Ready Reset signal is accessed via an SMA connector.

DRR is CMOS/LVCMOS compatible:

- $V_{IL} = 0$ (typical)
- $V_{IH} = V_{CCA3}$ (typical)

The active level depends on the Data Ready Reset of 3WSI function (refer to section 4.4.2)

This signal acts as an internal Reset of the device. It is not mandatory for proper operation of the device. It is only used to determine exactly the first data to be sampled.

When applied, the clock outputs are Reset. The Reset pulse should last at least 3.5 ns.

An asynchronous Reset (ASYNCRST push button) should be applied while DRR is active (high) in order to Reset properly the whole device.

In most cases (single channel application, no need to know which data will be the first one to be sampled), this Reset can be left unused.

5.6 DMUX Functions

5.6.1 ASYNCRST

The asynchronous Reset is mandatory to start the device properly. It should be applied after power up of the device.

A push button is provided to perform this Reset and pull-up and pull-down resistors allow to keep the ASYNCRST signal inactive.

Figure 5-2. ASYNCRST

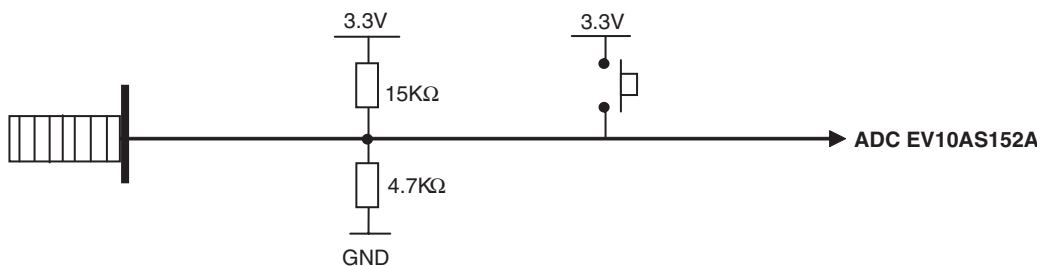

If the DRR Reset is also used, it is recommended to apply the asynchronous Reset while the DRR Reset is active.

The first data is available at the device output after $TOD + N$ cycles (with $4.5 \leq N \leq 7.5$ depending on DEMUX mode).

5.6.2 CLKDACTRL

A delay cell is provided to allow the user to tune the delay between the Clock and Data at the DMUX input. The delay is controlled via the CLKDACTRL potentiometer.

This cell allows you to delay the internal DMUX clock via the CLKDACTRL potentiometer (varying from $V_{CCD}/3$ to $(2 \times V_{CCD})/3$).

This pin must be biased and it is recommended to set CLKDACTRL at $V_{CCD}/3$. With this value it is normally not necessary to tune CLKDACTRL voltage over the full specified clock rate.

Figure 5-3. CLKDACTRL Potentiometer

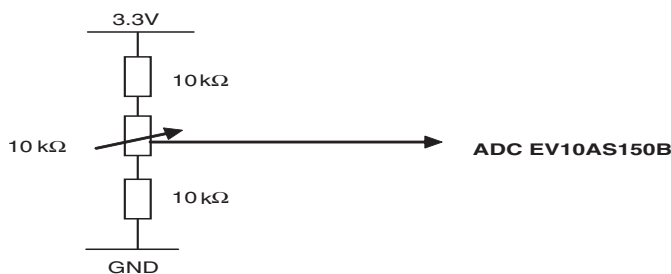

5.6.3 RS, DRTYPE, BIST, SLEEP, STAGG

Seven jumpers are provided for the RS, DRTYPE, BIST, SLEEP and STAGG functions. Table 5-1 describes each function.

Table 5-1. DMUX Function Settings and Description

| Function | Description | Jumper Settings |
|----------|---|--|
| RS | Ratio selection: - 1:2 - 1:4 | 1:2: Jumper ON 1:4: Jumper OUT |
| DRTYPE | Output clock mode: - DR = data valid on each rising edge of the DR/DRN signal - DR/2 = data valid on both rising and falling edges of the DR/DRN signal | DR: Jumper OUT DR/2: Jumper ON |
| BIST | Built-In Self Test: - Active: checker board pattern available at the device outputs - BIST inactive: normal mode | BIST: Jumper ON No BIST: Jumper OUT |
| SLEEP | Sleep mode - Active: the device is in a partial standby mode - SLEEP inactive: normal mode | SLEEP: Jumper ON SLEEP inactive: Jumper OUT |
| STAGG | Simultaneous or Staggered output mode - STAGG active: staggered output data - STAGG inactive: simultaneous output data | STAGG: Jumper ON STAGG inactive: Jumper OUT |

Figure 5-4. DMUX Functions Jumper Positions

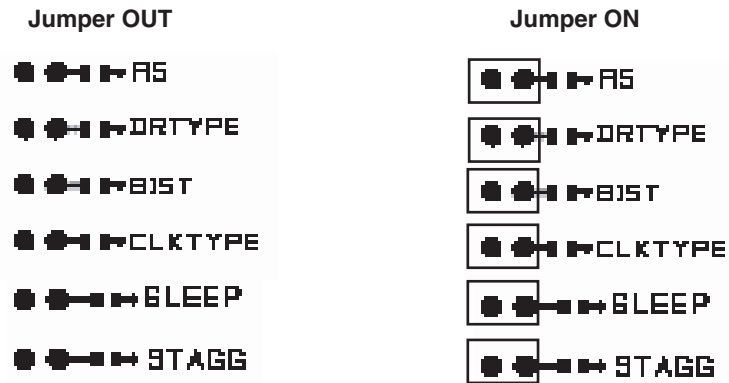

Jumper CLKTYPE can be placed in any position: it has no effect.

5.6.4 Additional OR Bits

In simultaneous mode, the out-of-range signal of the ADC is demultiplexed by the DMUX and output on all ports as the (AOR/DRAN, AORN/DRA), (BOR/DRBN, BORN/DRB), (COR/DRCN, CORN/DRC) and (DOR/DRDN, DORN/DRD) signals.

These signals can be used to detect if the input of the ADC is above the full scale.

In staggered mode, these signals correspond to the output clock for each port:

DRA, DRAN for Port A (pins A6, B6)

DRB, DRBN for Port B (pins J2, H1)

DRC, DRCN for Port C (pins W5, V5)

DRD, DRDN for Port D (pins W17, V17)

5.7 Diode for Die Junction Temperature Monitoring

Two diodes for die junction temperature measurement are available, for maximum junction temperature monitoring (hot point measurement) of both the ADC and the DMUX.

The measurement method consists in forcing a 1 mA current into a diode mounted transistor.

The measurement setup is described in Figure 5-5.

Figure 5-5. ADC DIODE Measurement Setup

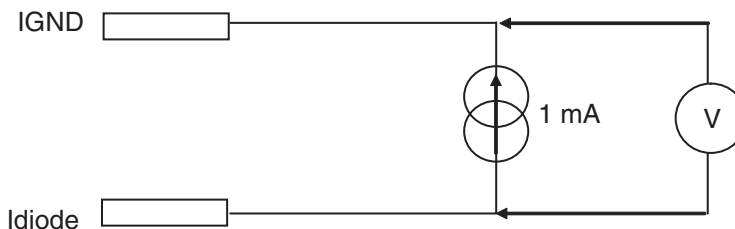

Note: The 1 mA current can be supplied by a multimeter set in this specific current source mode: in this case, the voltage measured between the diode pin and ground is displayed on the multimeter.

Figure 5-6. ADC DIODE Characteristics

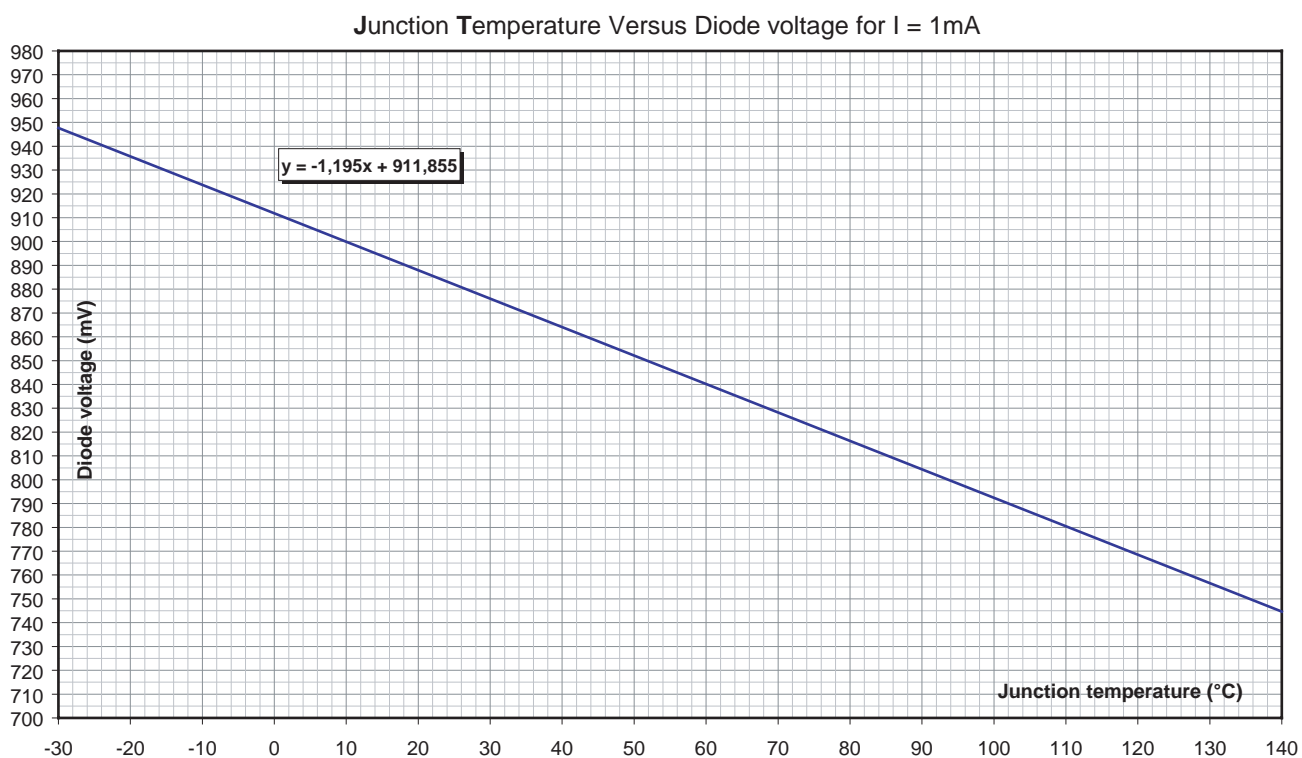

5.8 Test Bench Description

Figure 5-7. Test Bench Description

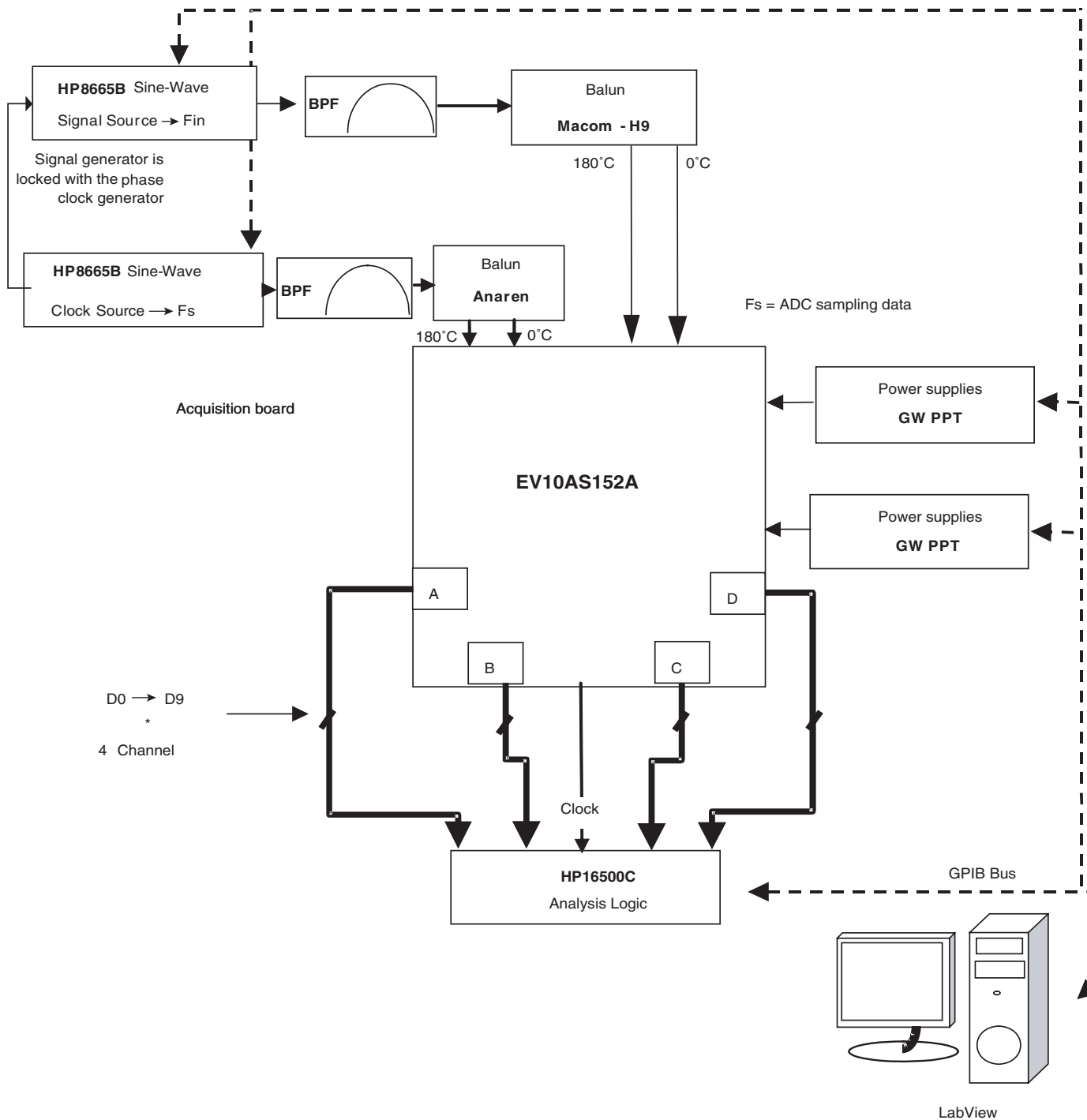

Package Information

6.1 Thermal Characteristics**Table 6-1.** Thermal Resistance (No air, pure conduction, no radiation)

| | Rth junction to bottom of balls | Rth junction to Top of Case | Rth junction to Board ⁽¹⁾ | Rth junction to ambient |
|--------------------|---------------------------------|-----------------------------|--------------------------------------|-------------------------|
| ADC block ON only | 7° C/W | 4.1° C/W | 8° C/W | 17.1° C/W |
| DMUX block ON only | 3.9° C/W | 1.5° C/W | 4.9° C/W | 13.9° C/W |

Note: 1. No external heatsink is mandatory.

Ordering Information

| Part Number | Package | Temperature Range | Screening | Comments |
|-----------------|----------|--------------------------|---|--|
| EV10AS152ATP-EB | EBGA 317 | Ambient | Prototype | For availability, contact your local e2v sales office. |
| EV10AS152ACTP | EBGA 317 | Commercial grade | $T_{amb} > 0^{\circ}\text{C}$, $T_J < 90^{\circ}\text{C}$ | For availability, contact your local e2v sales office. |
| EV10AS152AVTP | EBGA 317 | Industrial grade | $T_{amb} > -40^{\circ}\text{C}$, $T_J < 110^{\circ}\text{C}$ | For availability, contact your local e2v sales office. |
| EV10AS152ACTPY | EBGA 317 | Commercial grade RoHS | $T_{amb} > 0^{\circ}\text{C}$, $T_J < 90^{\circ}\text{C}$ | For availability, contact your local e2v sales office. |
| EV10AS152AVTPY | EBGA 317 | Industrial grade RoHS | $T_{amb} > -40^{\circ}\text{C}$, $T_J < 110^{\circ}\text{C}$ | For availability, contact your local e2v sales office. |

8.1 EV10AS152A-EB Electrical Schematics

Figure 8-1. Decoupling PIN

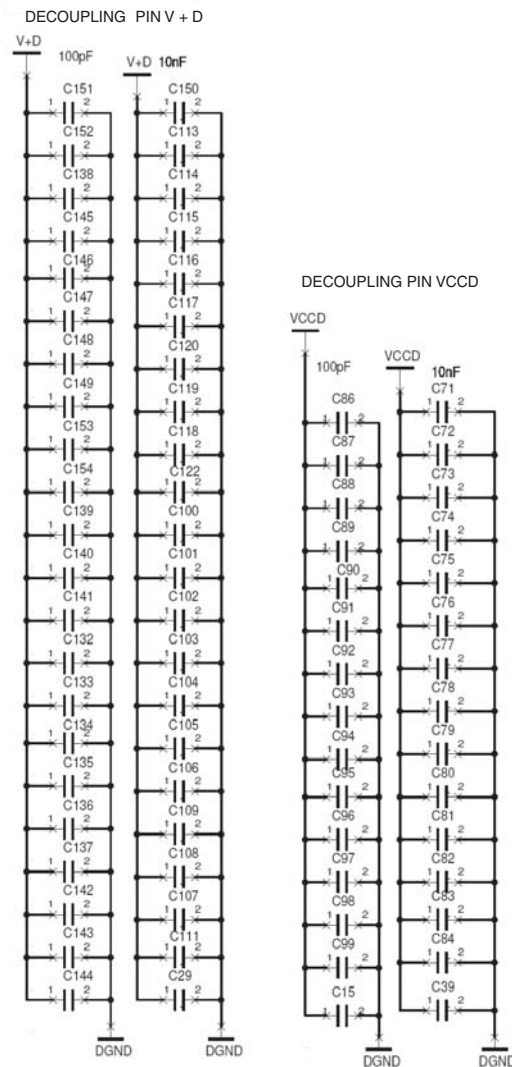

Note: 1. For ADC decoupling strategy, please do not take into account the current decoupling implemented on current evaluation board which is purely experimental. Refer to Datasheet for recommended decoupling strategy.

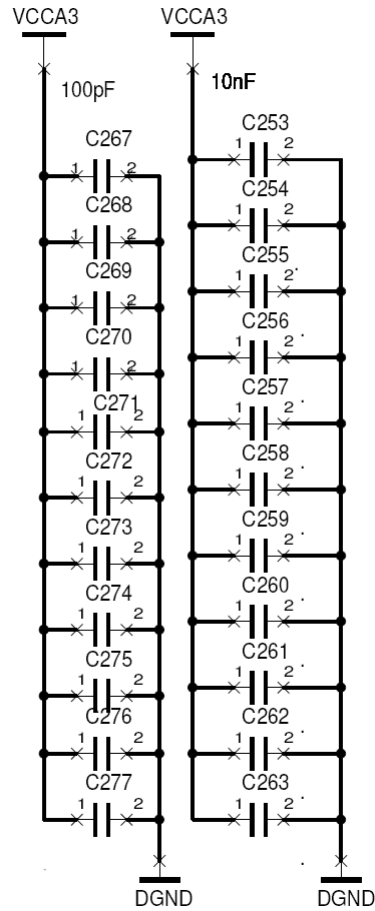
Figure 8-2. Decoupling PIN V_{CCA3}

- Note: 1. For ADC decoupling strategy, please do not take into account the current decoupling implemented on current evaluation board which is purely experimental. Refer to Datasheet for recommended decoupling strategy.

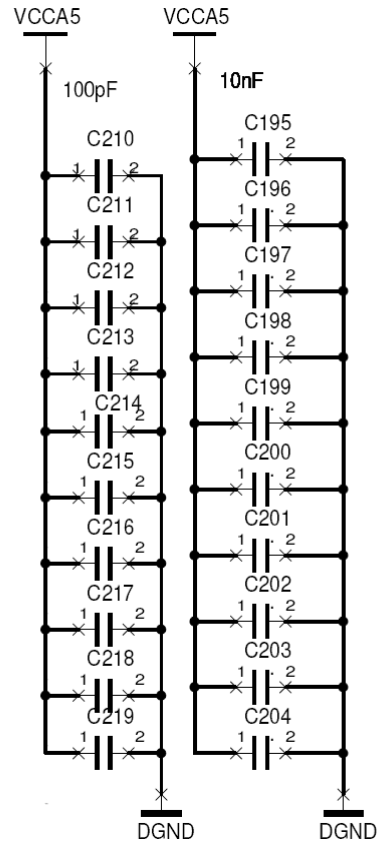
Figure 8-3. Decoupling PIN V_{CCA5}

- Note: 1. For ADC decoupling strategy, please do not take into account the current decoupling implemented on current evaluation board which is purely experimental. Refer to Datasheet for recommended decoupling strategy.

Figure 8-4. Power Supplies Connections

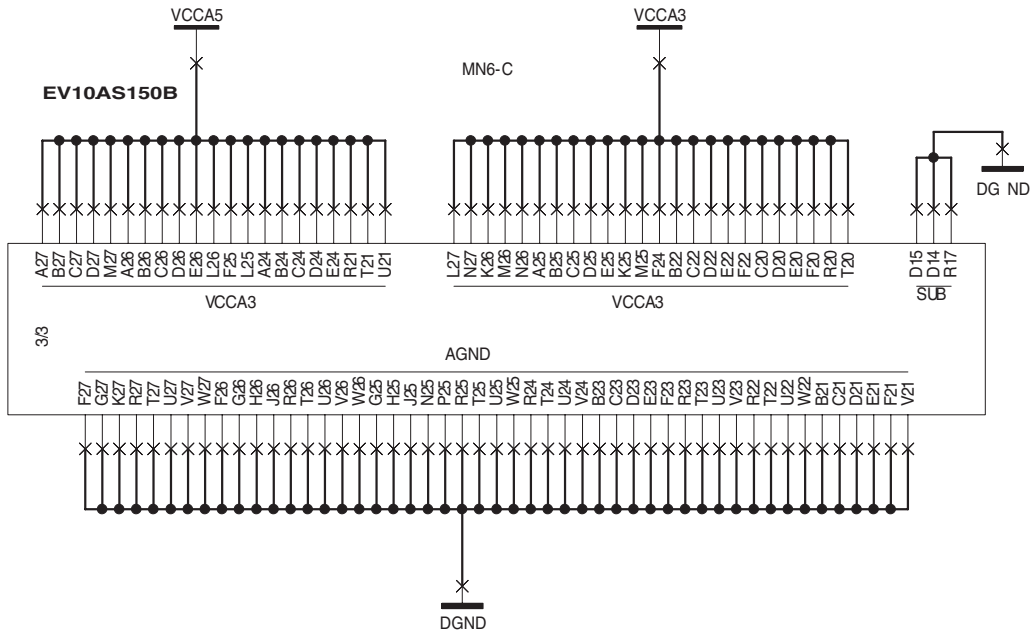

Figure 8-5. Power Supplies Bypassing

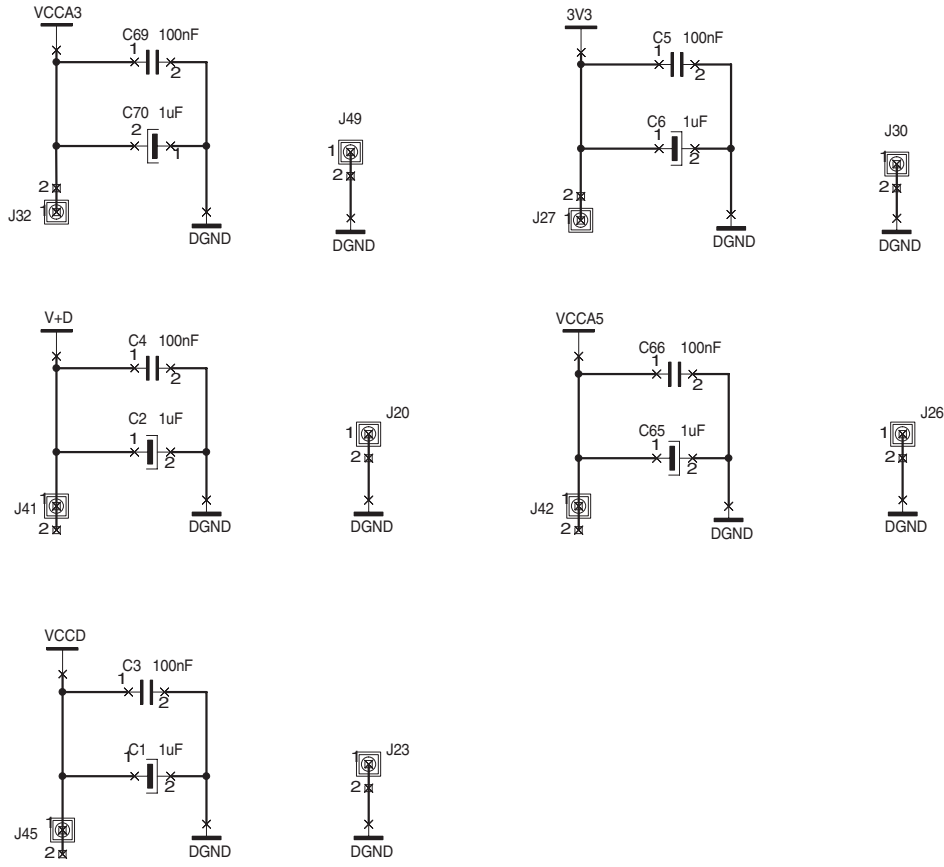
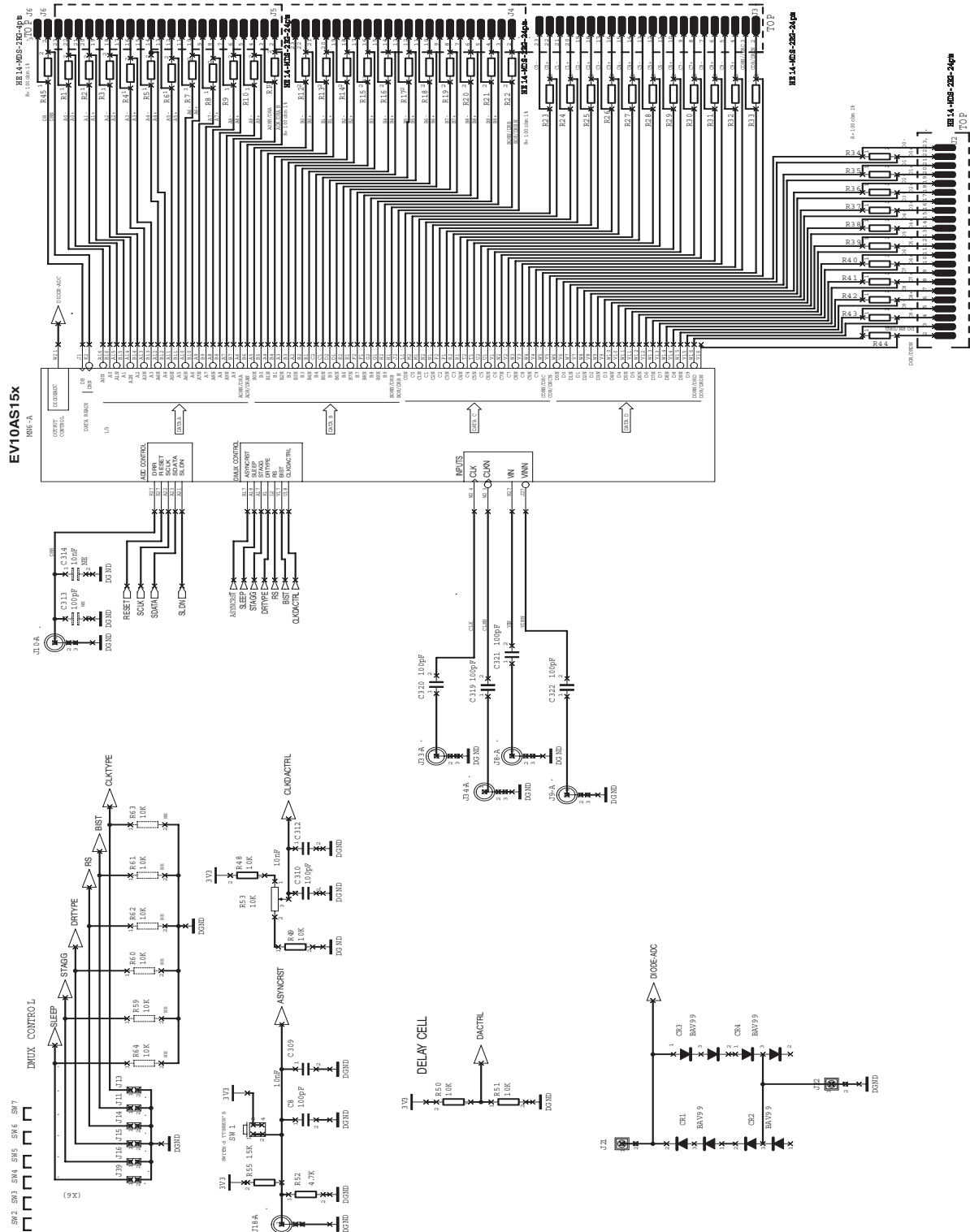

Figure 8-6. EV10AS152A-EB Electrical Schematic (ADC DMUX)



8.2 EV10AS152A-EB Board Layers

Figure 8-8. Top Layer

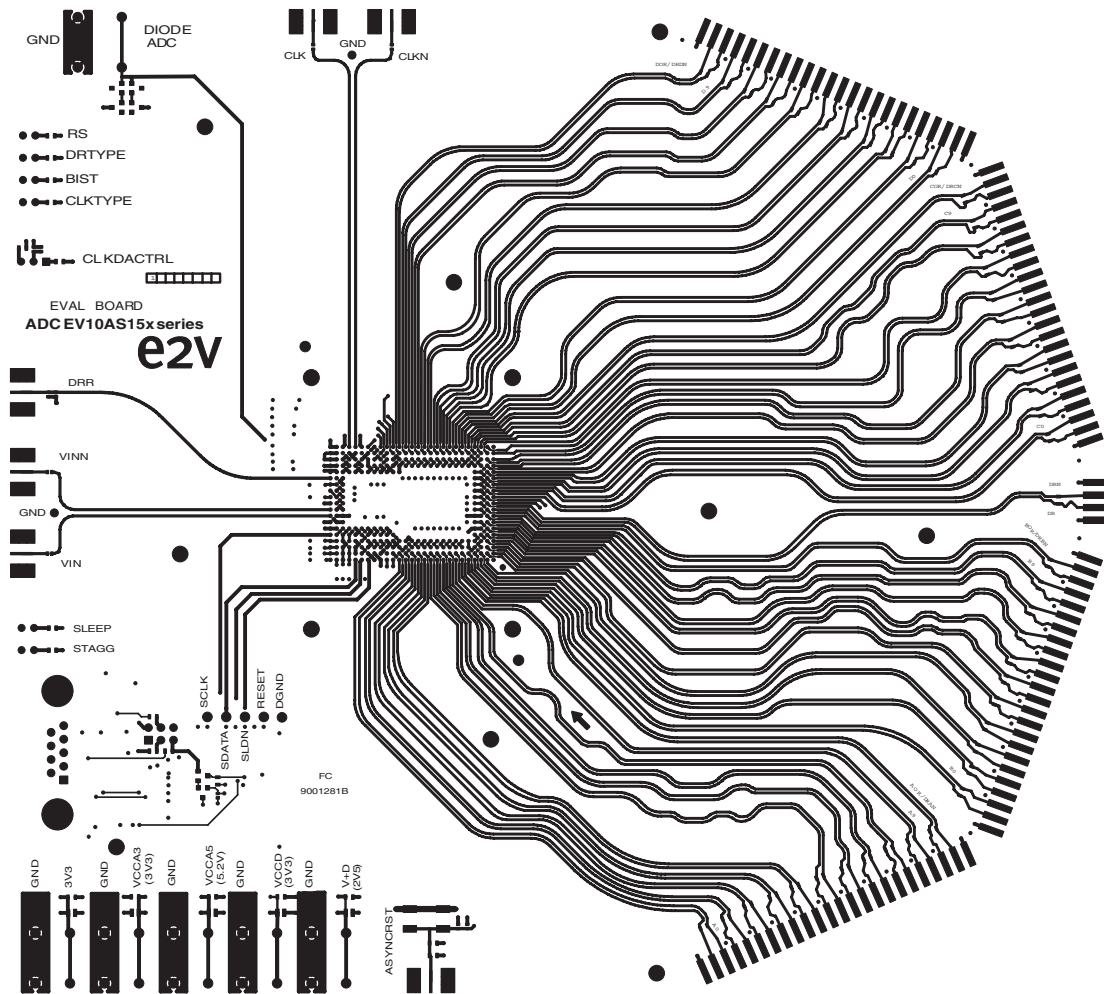

Figure 8-9. Bottom Layer

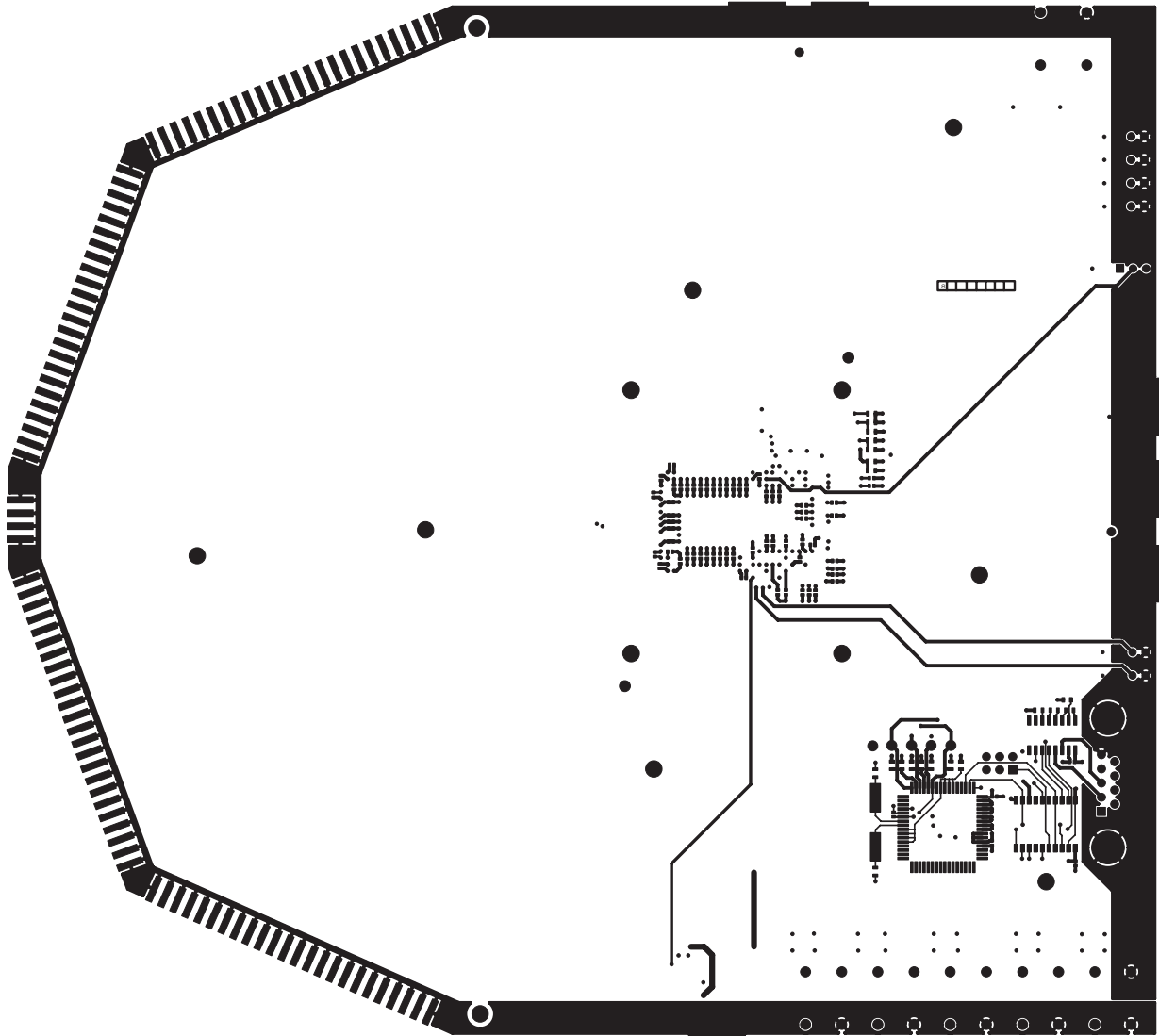

Figure 8-10. Board Equipped with Socket (Top)

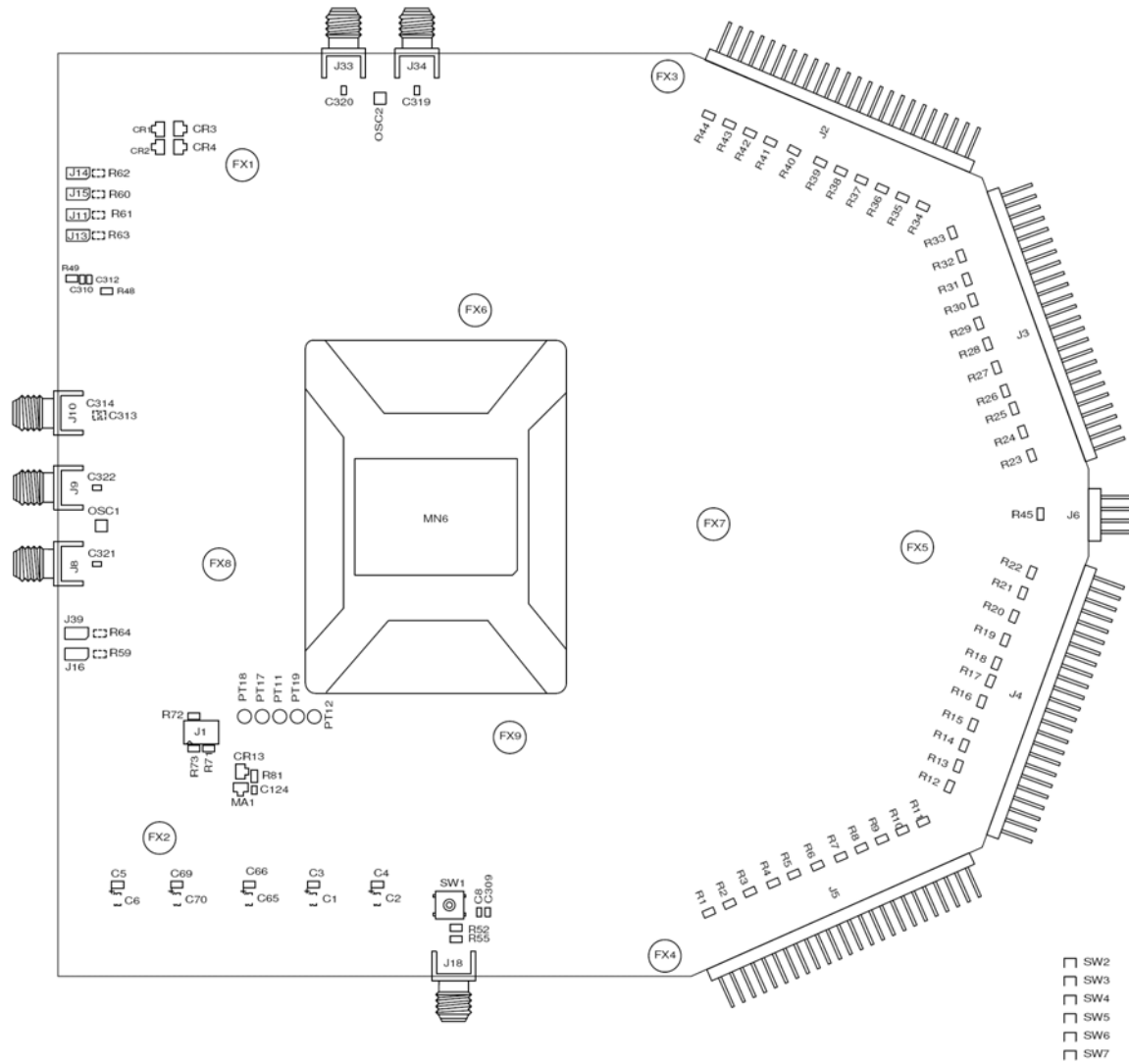
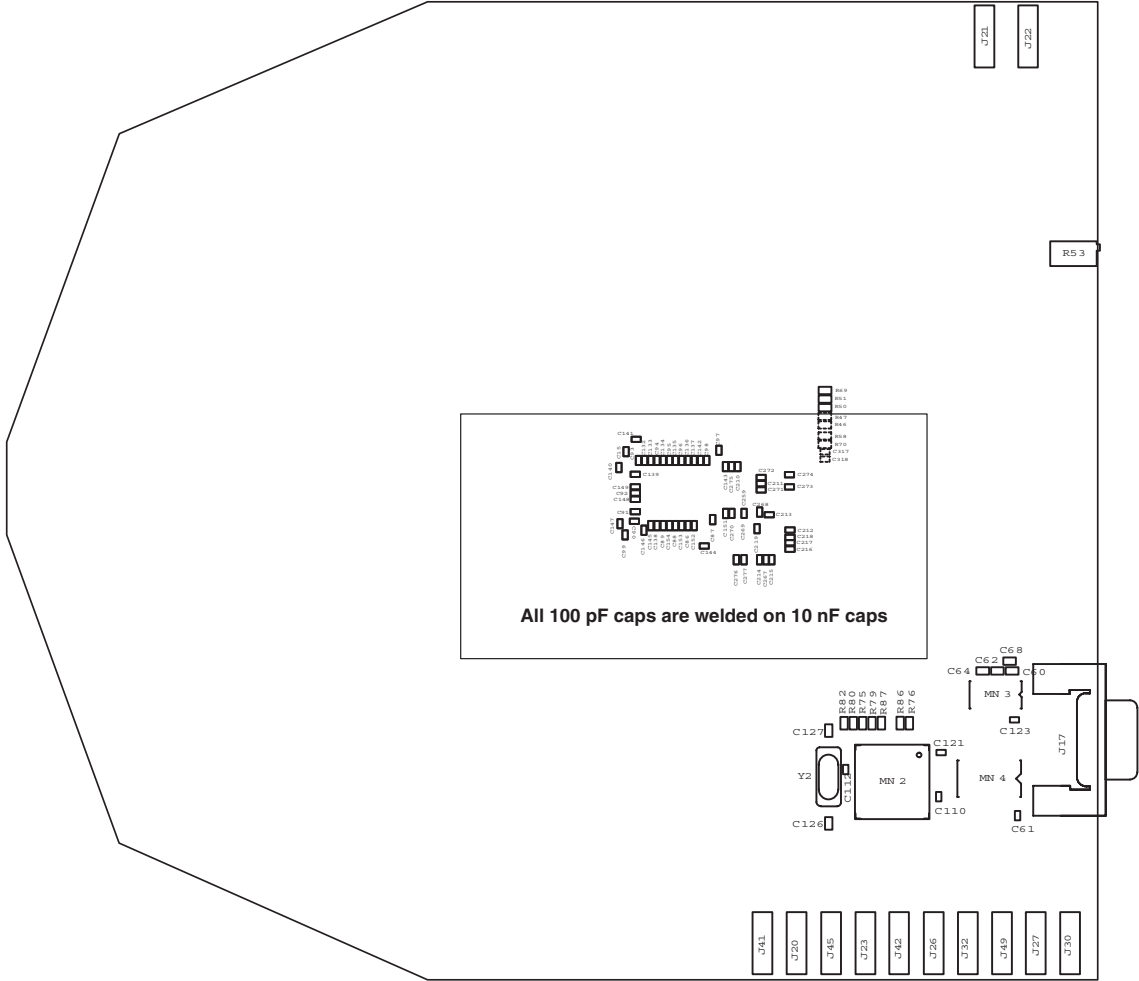

Figure 8-11. Equipped Board (Bottom)





How to reach us

Home page: www.e2v.com

Sales offices:

Europe Regional sales office

e2v ltd

106 Waterhouse Lane
Chelmsford Essex CM1 2QU
England

Tel: +44 (0)1245 493493

Fax: +44 (0)1245 492492

mailto: enquiries@e2v.com

e2v sas

16 Burospace
F-91572 Bièvres Cedex
France

Tel: +33 (0) 16019 5500

Fax: +33 (0) 16019 5529

mailto: enquiries-fr@e2v.com

e2v Aerospace and defense inc

765 Sycamore Drive
Milpitas
California 95035
USA

Tel: +33 (0) 1 408 737 0992

Fax: +33 (0) 1 408 736 8708

mailto: e2v-us.com

Americas

e2v inc

520 White Plains Road
Suite 450 Tarrytown, NY 10591
USA

Tel: +1 (914) 592 6050 or 1-800-342-5338,

Fax: +1 (914) 592-5148

mailto: enquiries-na@e2v.com

Asia Pacific

e2v ltd

11/F.,
Onfem Tower,
29 Wyndham Street,
Central, Hong Kong

Tel: +852 3679 364 8/9

Fax: +852 3583 1084

mailto: enquiries-ap@e2v.com

Product Contact:

e2v

Avenue de Rochepleine
BP 123 - 38521 Saint-Egrève Cedex
France

Tel: +33 (0)4 76 58 30 00

Hotline:

mailto: hotline-bdc@e2v.com

Whilst e2v has taken care to ensure the accuracy of the information contained herein it accepts no responsibility for the consequences of any use thereof and also reserves the right to change the specification of goods without notice. e2v accepts no liability beyond that set out in its standard conditions of sale in respect of infringement of third party patents arising from the use of tubes or other devices in accordance with information contained herein.